

Oblica Fire Table - Specs

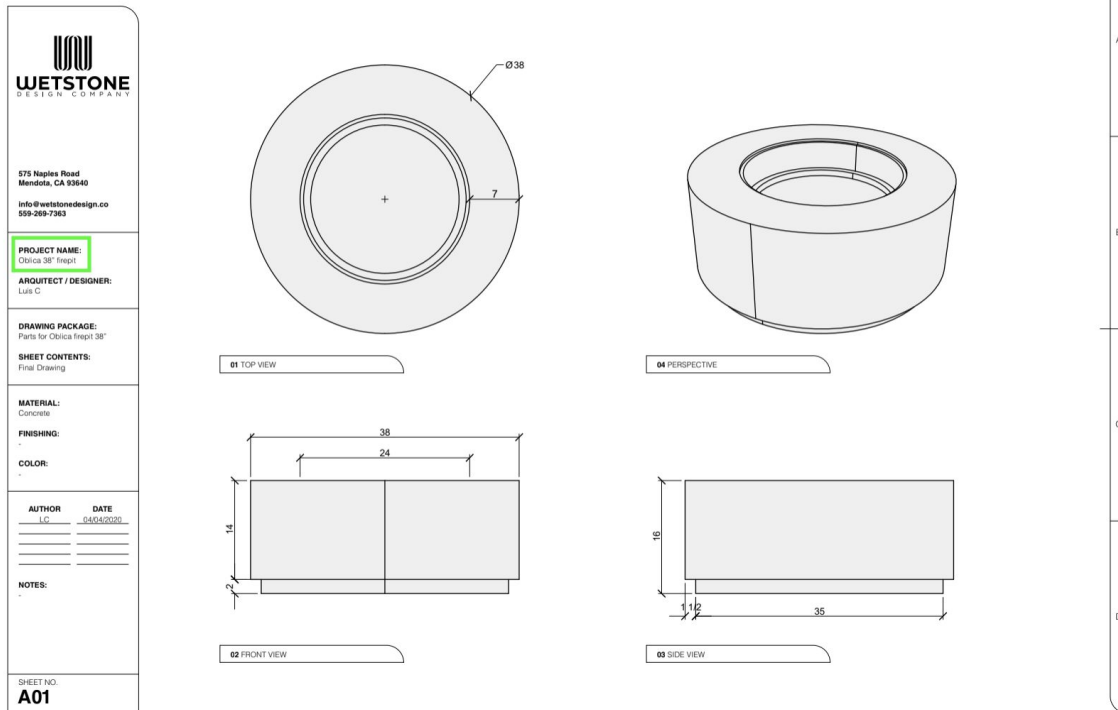
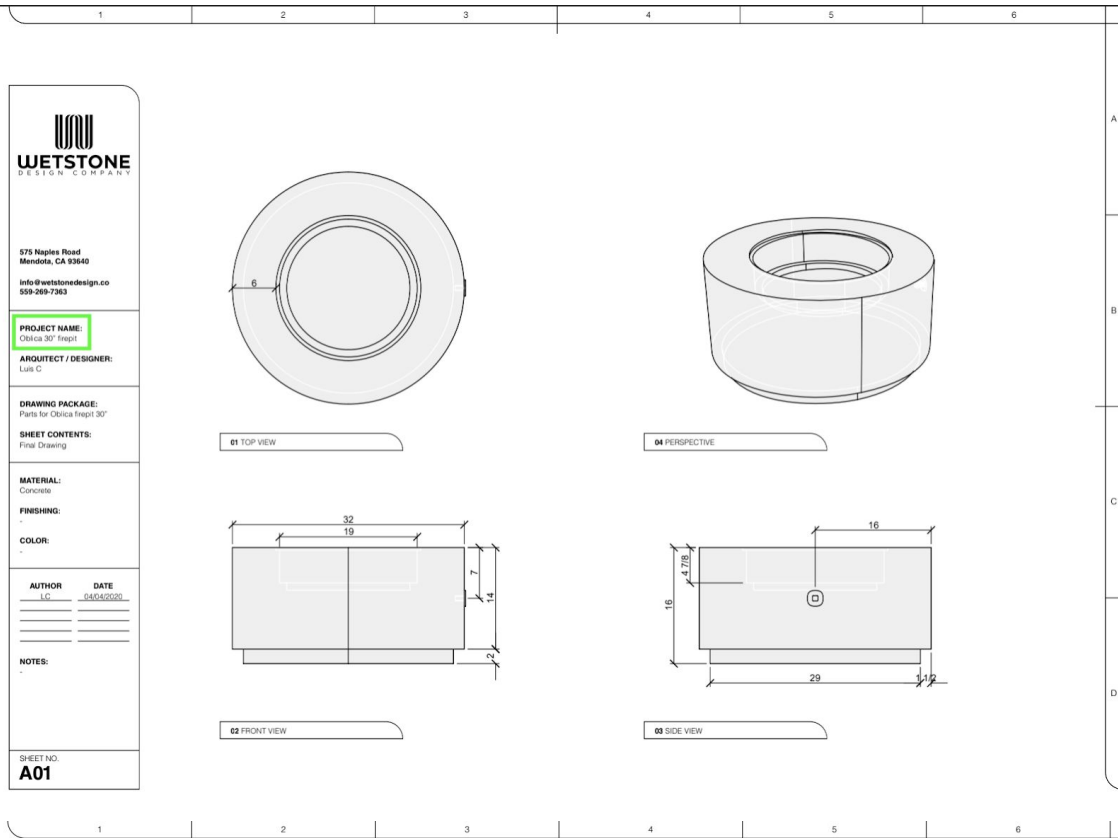

WETSTONE
DESIGN COMPANY

575 Naples Road
Mendota, CA 93640
info@wetstonedesign.co
509-269-7363

PROJECT NAME:
Oblica 55" frep1

ARQUITECT / DESIGNER:
Luis C

DRAWING PACKAGE:
Parts for Oblica frep1 55"

SHEET CONTENTS:
Final Drawing

MATERIAL:
Concrete

FINISHING:
-

COLOR:
-

AUTHOR	DATE
LC	04/04/2020

NOTES:
-

SHEET NO.
A01

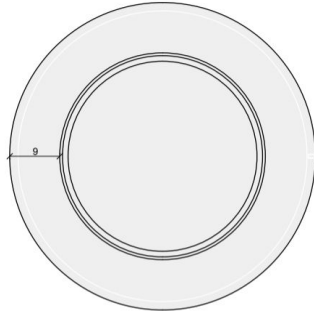

01 TOP VIEW

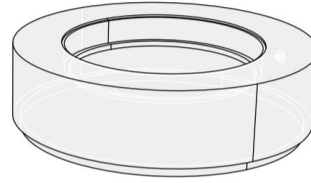

04 PERSPECTIVE

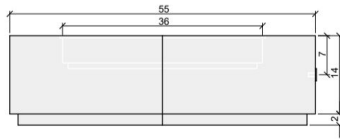

02 FRONT VIEW

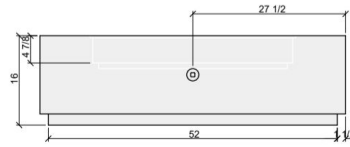

03 SIDE VIEW

WETSTONE
DESIGN COMPANY

575 Naples Road
Mendota, CA 93640
info@wetstonedesign.co
509-269-7363

PROJECT NAME:
Oblica 45" frep1

ARQUITECT / DESIGNER:
Luis C

DRAWING PACKAGE:
Parts for Oblica frep1 45"

SHEET CONTENTS:
Final Drawing

MATERIAL:
Concrete

FINISHING:
-

COLOR:
-

AUTHOR	DATE
LC	04/04/2020

NOTES:
-

SHEET NO.
A01

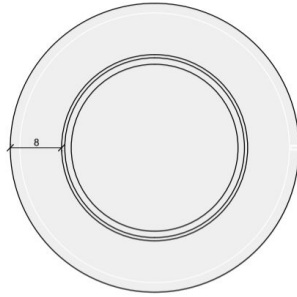

01 TOP VIEW

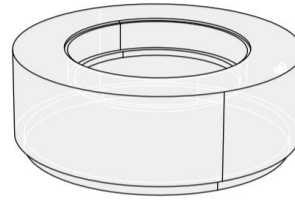

04 PERSPECTIVE

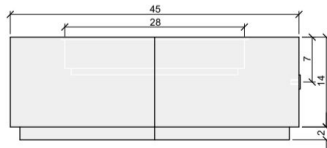

02 FRONT VIEW

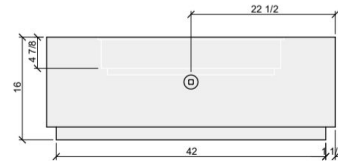

03 SIDE VIEW



575 Naples Road
Menlo Park, CA 94025
info@wetstonedesign.co
569-269-7363

PROJECT NAME:
Oblica 65" Teept
ARCHITECT / DESIGNER:
Luis C.

DRAWING PACKAGE:
Plans for Oblica Teept 65"
SHEET CONTENTS:
Final Drawing

MATERIAL:
Concrete
FINISHING:

COLOR:

AUTHOR	DATE
LC	04/04/2020

NOTES:

SHEET NO.
A01

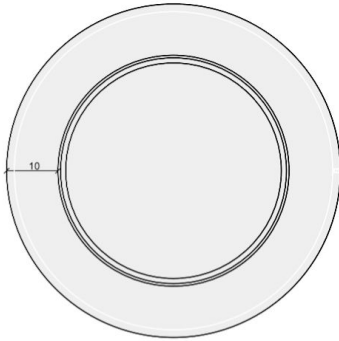

01 TOP VIEW

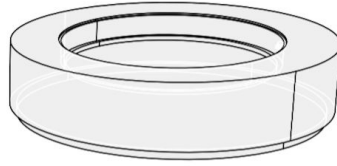

04 PERSPECTIVE

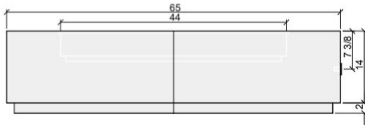

02 FRONT VIEW

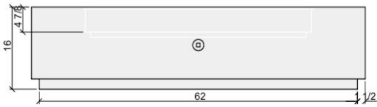

03 SIDE VIEW

A
B
C
D